

Quick Start Guide

5GHz 19dBi Dual-Polarization Directional Base Station Antenna

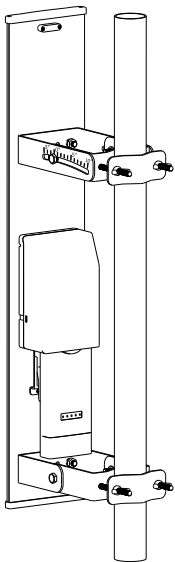

Package Contents

- Antenna×1
- U-Bracket×2
- Quick Start Guide×1
- RF Cables×2

before use this equipment, please read this guide for installing equipment quickly.



the wireless radio from this guide (Sold separately)

Installation Requirements

- 13mm wrench
- Shielded Category 5 (or above) cabling should be used for all wired Ethernet connections and should be grounded through the AC ground of the PoE. We recommend that you protect your networks from the most brutal environments and devastating ESD attacks with industrial grade shielded Ethernet cable.

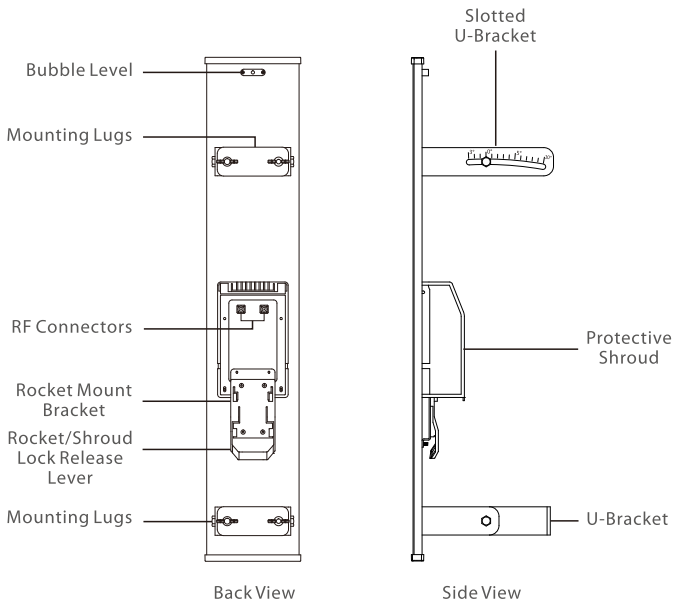

Bracket Installation

- ① Open the waterproof cover, attach the RF Cables to the connectors of antenna
- ② Press the bracket handle, align the mounting tabs on the back of the Station with the four mounting slots on the bracket, Slide the Rocket down until it locks into place.

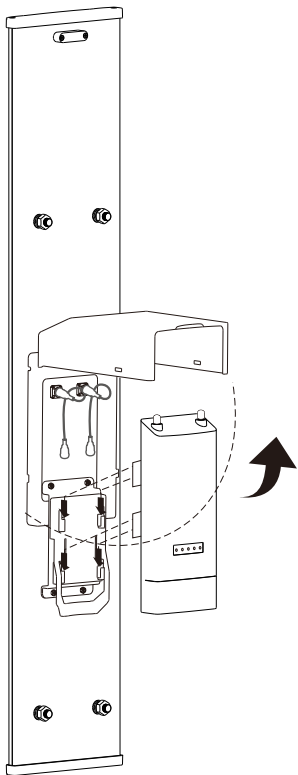

- ③ Unscrew the plastic nut on the interface of station
- ④ Connect the other end of the 2 RF cables to the station and close waterproof cover.

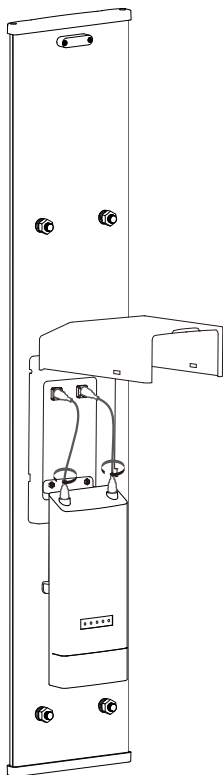

- ⑤ Secure the Slotted U-Bracket to the upper Mounting Lugs of the antenna using two nuts. Secure the Slotted U-Bracket to the lower Mounting Lugs of the antenna using two nuts.

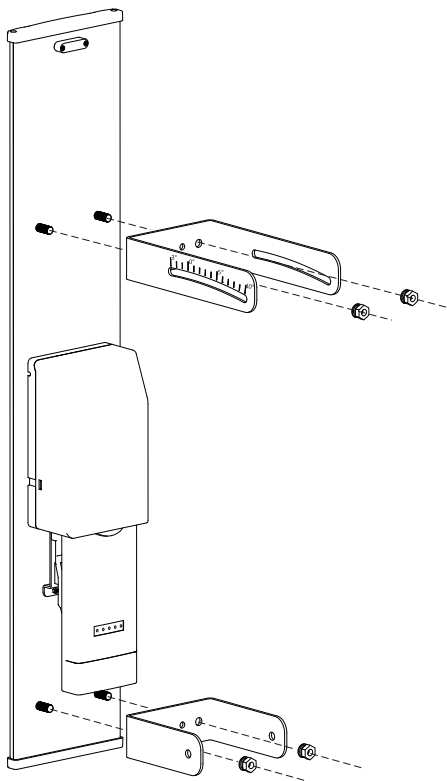

- ⑥ Open the antenna small fixing clip, fix the two small fixing clips to the pole with the disc mother, and mount the antenna to the pole.
- 📄 Note: The mounting assembly can accommodate a $\varnothing 30 - 70$ mm pole.

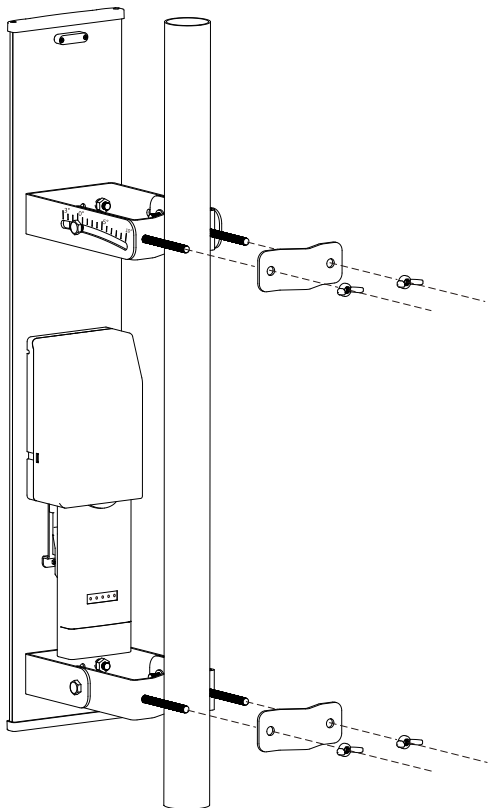

⑦ Completed installation.

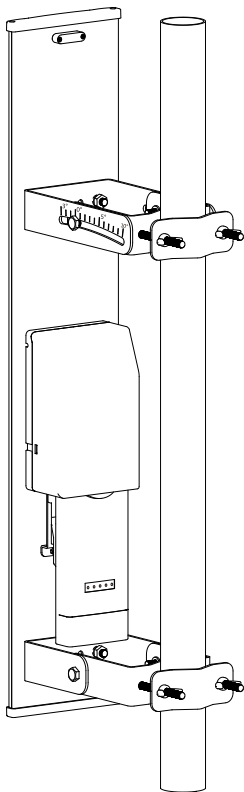

- ⑧ The antenna has a Mechanical downtilt of 4°. To further adjust the elevation angle:
- loosen four bolts on the U bracket and two butterfly nuts on the pole clamp.
 - Slide the antenna to the desired tilt.
- (The brackets may slide along the pole, depending on the angle of the elevation tilt)
- Tighten all bolts and nuts to approximately 25 N-m.

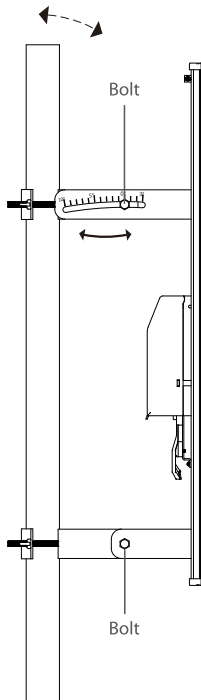

Technical Specifications

Electrical	
Model	ANT19-5G120
Frequency Range	5100-5850MHz
Gain	18dBi \pm 1.5dBi
Polarization	Vertical and Horizontal
Isolation	>25dB
F/B Ratio	>25dB
Horizontal Beamwidth(6dB)	120° type
Vertical Beamwidth(3dB)	4° type
V.S.W.R	<2
Max Power	20W
Nominal Impedance	50 Ω
Lightingprotection	DC Ground
Mechanical	
Connector	2 x RPSMA
Antenna Size	78.5 \times 15 \times 2cm
Antenna Weight	3kg
Colour	gray
Antenna cover material	UV Protection ABS
Operatingt emperature	-40°C to +70°C (-32°F to +158°F)
ETSI Specification	ETS 300 019-1-4, EN 302 085(ANNEX A.1.1)

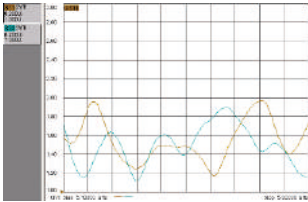

Antenna Voltage V.S.W.R

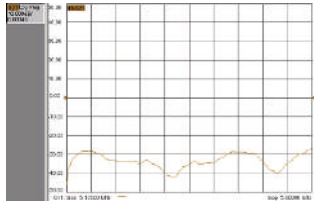

Port Isolation

Antenna Pattern

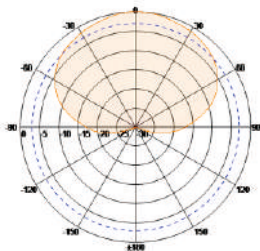

V-Pol Azimuth

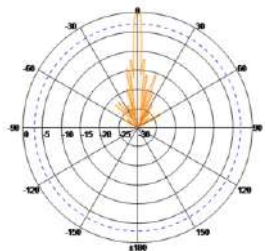

V-Pol Elevation

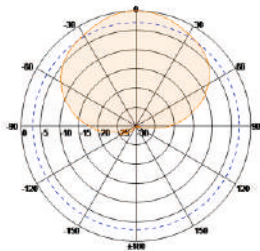

H-Pol Azimuth

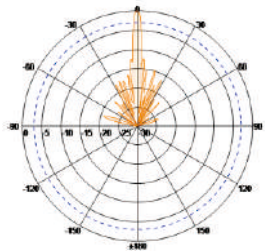

H-Pol Elevation